

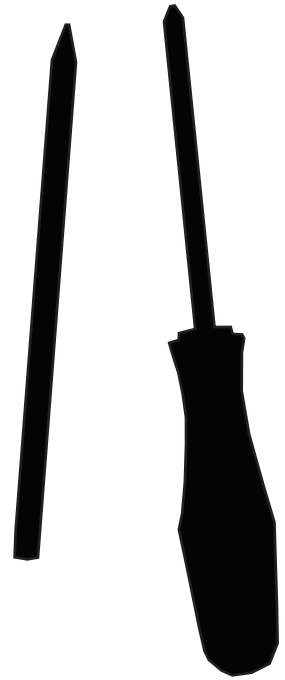

We have made the shelving system as simple as possible to install and any competent builder or handyman should be able to fit the system. Please follow the guide accurately as it's important to install the system correctly and the quality of the installation can effect its performance. The size of load it can carry will also depend on the strength of the wall (eg brick or plasterboard) and the fixing method to carry its load (wall plugs or cavity wall fixings).

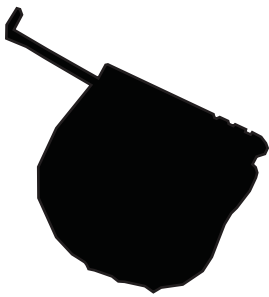

NB* PIPES AND ELECTRICS

Before drilling any holes in your walls always check for any services behind (pipes & cables). Detectors are available from most DIY stores and once installed never sit or stand on your shelving system.

WORKING AT HEIGHT

Ensure you follow suitable health & safety guidelines when working at height. Our systems are usually fitted below 2.4metres in height and only a small height increase may be required. We recommend using a suitable, stable and level 'work platform' to install from and not a ladder when drilling holes.

LONG SHELVES

We would recommend using 2 people to fit our shelving system if any of the shelves are over 3 metres in length. Our deepest shelves (345) can also weigh up to 24kgs (5m length).

The diagram below shows all the parts to the standard system and how they go together. The wall rails screw directly into the wall, all the other parts are connected to them creating a very strong wall shelving system. Your system may not have all these parts but the principles will be the same.

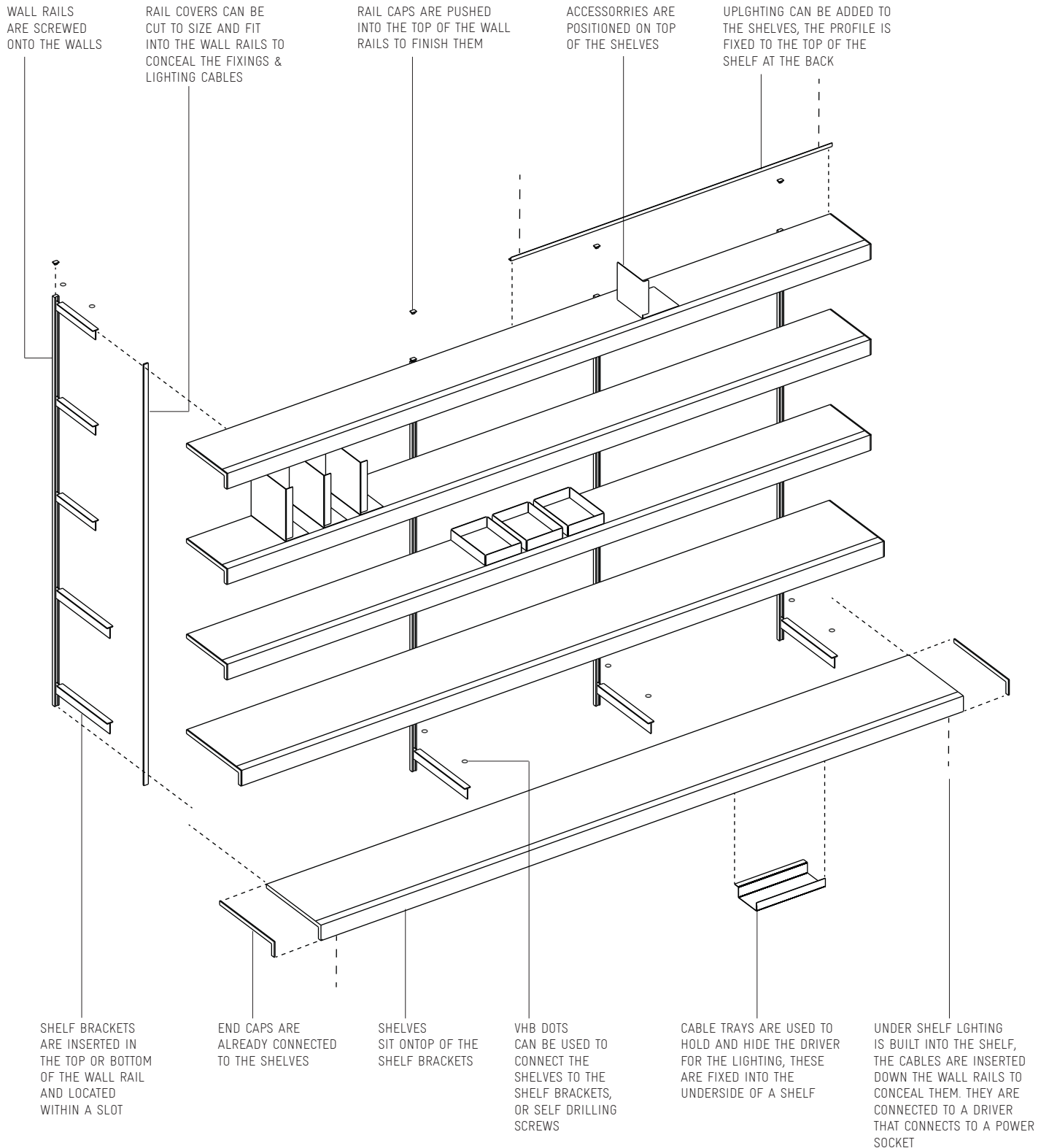

The diagram below shows additional parts to the shelving system and how they go together. These parts can be designed into your system at the beginning or added to at a later stage. If you want to move your system in the future and if required we can also resize your shelves and rails to suite a new configuration.

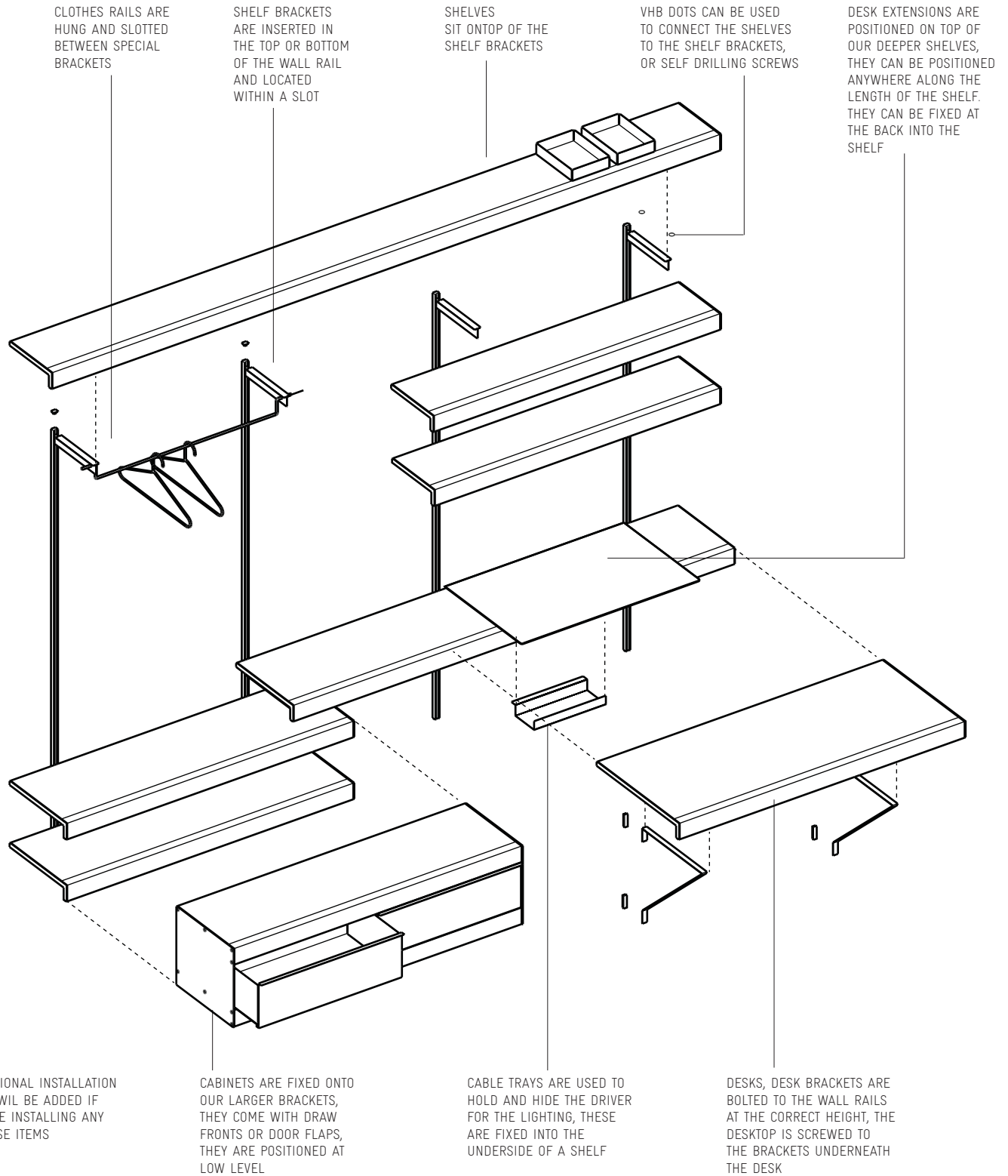

It is important to know what type of wall you are fixing the shelving system to. Below we have listed the most common types of wall and our fixing method. We supply solid and cavity fixings as standard, but if you have any problems or would like fixings that work with Dot and Dab platerboard walls please let us know.

NB* When you are drilling holes in the wall ensure you wear safety glasses or similar to protect your eyes

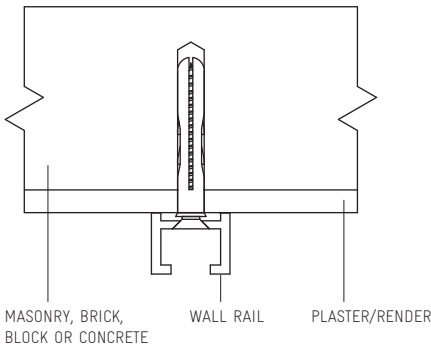

WALL PLUG FOR BRICK AND MASONRY
 DRILL DIAMETER 5.5MM
 DRILL DEPTH 35MM

SCREW 40MM
 COUNTERSUNK
 GAUGE 8

SOLID WALLS (GOOD QUALITY)

Use the hammer setting on the drill. Drill the hole (40mm deep) with a masonry drill bit and use a hammer setting, then clean the hole. Insert the plug and tap until flush with the wall. Tighten the screw using the correct screwdriver. If the plug spins or does not hold the screw tight try using the larger wall plugs below. (You can redrill the existing hole larger)

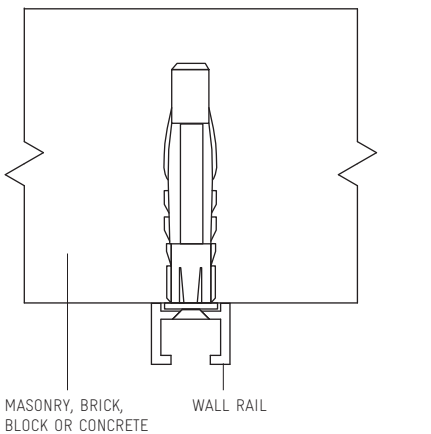

WALL PLUG FOR BRICK AND MASONRY
 DRILL DIAMETER 8MM
 DRILL DEPTH 55MM

SCREW 50MM
 COUNTERSUNK
 GAUGE 8

SOLID WALLS (POOR QUALITY)

Use the hammer setting on the drill. Drill the hole (55mm deep) with a masonry drill bit and then clean the hole. Insert the plug and tap until flush with the hole. Tighten the screw using the correct screwdriver. We would always recommend tightening the last part by hand to ensure you don't overtighten (you don't want the plug to fail) You should be able to keep tightening the screw by hand until it stops rotating.

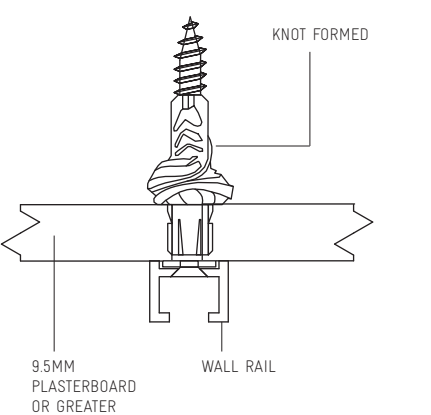

WALL PLUG FOR CAVITY WALLS
 DRILL DIAMETER 8MM
 DEPTH 55MM

SCREW 50MM
 COUNTERSUNK
 GAUGE 8

CAVITY WALLS (PLASTERBOARD)

Use this universal wall plug for any cavity wall or plasterboard wall that has a thickness of 9.5mm or more. Fitted correctly these are exceptionally strong, they require the longer screws supplied (50mm). When tightened the screw pulls the plug back to form a knot behind the plasterboard.

Drill a 8mm diameter hole through the plasterboard, insert the wall plug and, tap it with a hammer until the collar is flush with the plasterboard. Use a powered screwdriver to tighten the screw partially fitting the rail against the plasterboard. Do not over-tighten (as it could cause the plug to fail). It is best to do the final tightening by hand. You should be able to tighten it until it almost goes solid with no movement from the screw. If the screw ever spins after fully tightening remove the wall plug with pliers from the wall and insert another.

The system can take very heavy loads, but it does depend on the quality of the installation, quality of wall and fixing method. We recommend that all the fixing points on the wall rails are used (every 15cm) and that the appropriate fixing is used for your wall type, please see our wall types & Installation Guide.

NB* You must not sit or stand on any part of the shelving system.

1. Our recommended height between shelves is over 33.5cm (335mm). Alternatively they can be positioned at any distance apart in 5cm (50mm) increments.

2. The wall rail centres are positioned 80cm apart and the shelves are centred horizontally across them.

3. We would not recommend spanning a distance greater than 1200mm between the wall rails. Ensure the rails are set out correctly so that both remaining ends of the shelves are equal in length and over 20cm (200mm). This ensures stability and helps to create an equal load.

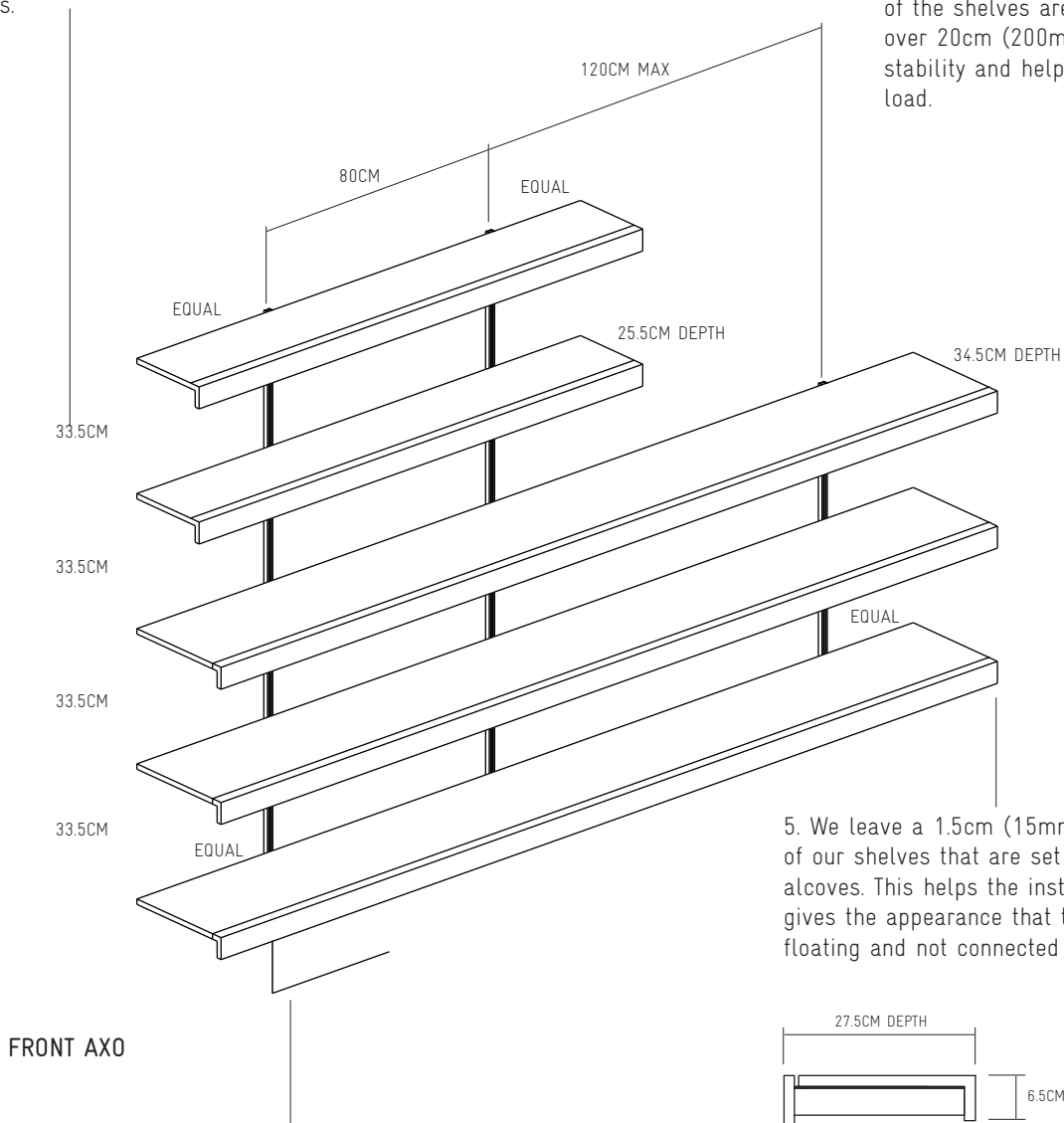

5. We leave a 1.5cm (15mm) gap either side of our shelves that are set between walls or alcoves. This helps the installation and gives the appearance that the shelves are floating and not connected to the wall.

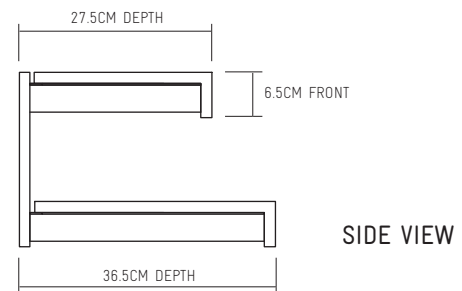

4. Our lighting shelf uses low energy led strips. The led cables are concealed within the shelf and run down the inside of a wall rail. The driver that powers the strips can be located on the underside of the bottom shelf or fixed to the wall but the driver does need to be connected to a standard power socket (UK unless requested).

6. Shelf depth, add an additional 2cm for the wall fixings, the total shelf depths are 27.5cm and 36.5cm from the wall to front face of the shelves.

Follow the steps below to fit your shelves, wall panels and connect your lighting. We will provide you with the correct setting out drawings and fixings for your walls. but If you do not want to install the system yourself, any competent builder or handyman will be able to fit the system for you.

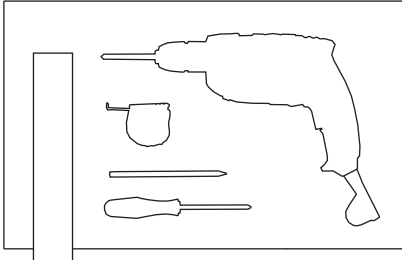

01 TOOLS FOR THE JOB

Tools for the job:
Tape measure, pencil, spirit level (80-100cm) drill (power), screwdriver (power), suitable wall fixings, detector (cables & pipes).

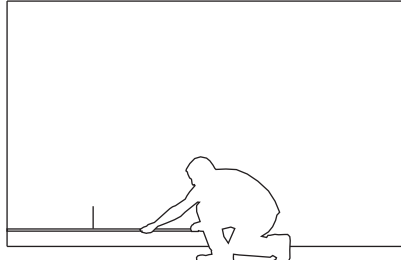

02 MARK OUT THE RAILS

Use our quotation as a template to set out your shelves. Mark out the horizontal position of the first wall rail. Use a tape measure to measure the correct distance away from a side wall, edge or fixed point and mark the centre of the first wall rail on the wall.



03 MARKING THE HEIGHT

Mark out the height of the top of the first wall rail. Mark the wall rail top hole which is labeled, this should be aligned directly above your first horizontal wall mark in step 01. The top of any wall panels being fitted will be 2cm above this point.

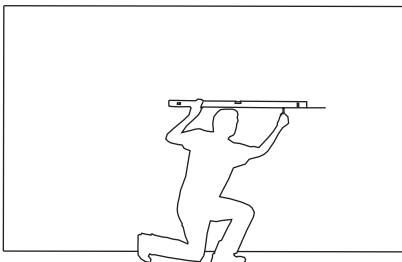

04 THE OTHER RAILS

At the same height use a spirit level to mark out the location of the other wall rail top holes, rails are usually set out every 80cm/800mm but check your setting out drawings for the correct dimensions.

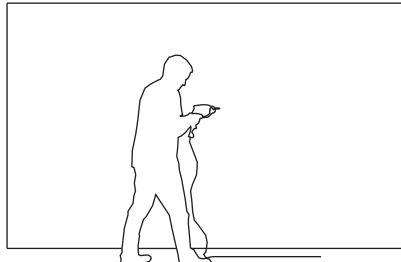

05 FIXING A WALL RAIL

Drill the top hole for the first rail. Use the appropriate drill bit/ wall fixing and insert the wall plug or cavity fixing. The accuracy of this position is important so drill a pilot hole first with a smaller diameter drill bit.

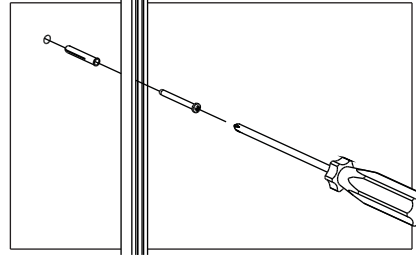

06 WALL RAIL

Begin to screw in the wall fixing and rail against the wall but do not tighten. The wall rail will now hang in place. We recommend using all the fixing points/holes but may not be necessary depending on your wall type and load.

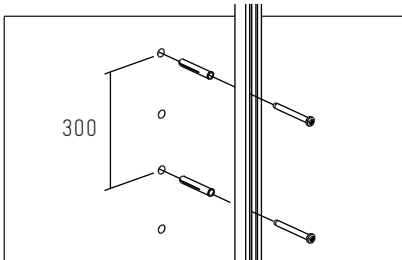

07 WALL FIXINGS QUANTITY

Your wall rails have fixing points every 15cm/150mm but if you are fixing your system to solid walls (brick/concrete block etc) you may be able to use only every other point 30cm/300mm, but this does depend on the quality of the wall or loading required.

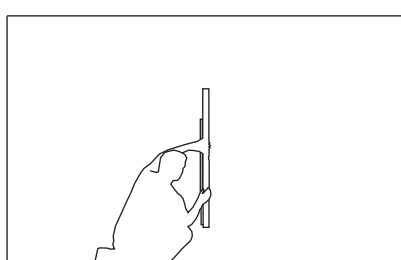

08 ALL VERTICAL

Ensure the wall rail is hanging vertically using a spirit level or plum line and use the rail holes to mark out the centres of the remaining holes. Re-check your hole locations as it's important they are accurate.

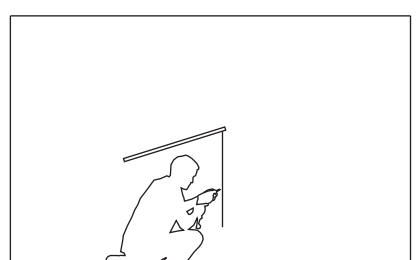

09 MAKE THE HOLES

Swing the rail to one side and drill all the holes marked out to the correct depth and clean the holes to remove any loose particles or dirt. Insert your wall plugs or wall cavity fixings and locate correctly.

Continue following the next steps below to fit your shelves, rail covers and wall panels. If there are any problems during the installation we are always happy to help, you can contact us on +44 (0)1727 834034 or email us at studio@madebyonandon.com.

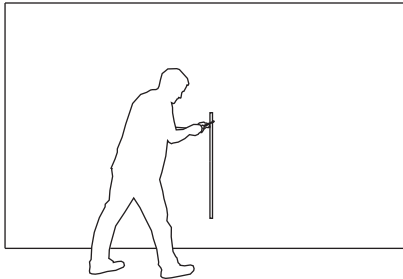

10 CONNECT THE RAIL

Insert the remaining fixings into the wall and tighten the screws against the rail. Repeat this for all the other wall rails. The rails should now be firmly connected to the wall. if you are fitting wall panels go to part (16)

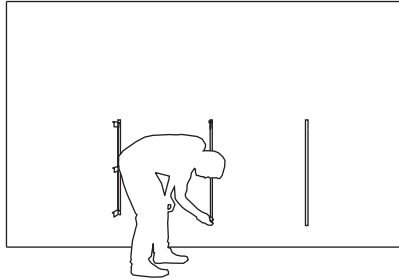

11 SHELF BRACKETS

With all the wall rails fixed in place you can slide the shelf brackets into the wall rail either from the top or bottom. The back of the bracket locates into the rail slots. The height of the bracket determines the position and height of the shelves.

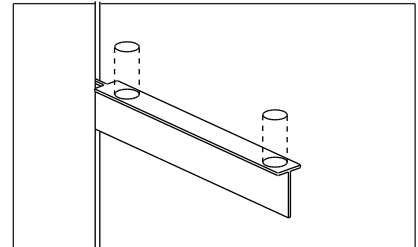

12 FIXING YOUR SHELVES

For additional security you can use our VHB dots they can be attached to bond the shelf to the bracket, but these are not always essential, just peel off the paper backing. If you need to remove the shelf the dot can be cut off with a long segment blade knife.

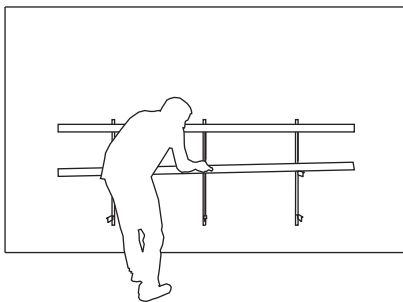

13 FITTING YOUR SHELVES

Ensure the brackets are at the correct heights you would like, they adjustable vertically by 5cm/50mm up or down, so adjust the heights until you are happy and lift the shelves onto the brackets.

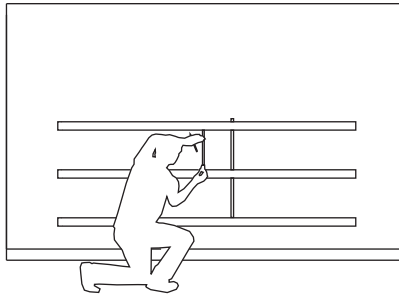

14 WALL RAIL COVERS

These can be fitted to exposed wall rails to conceal their screw fixings, or if you are fitting shelves with lighting they will conceal any lighting cables.

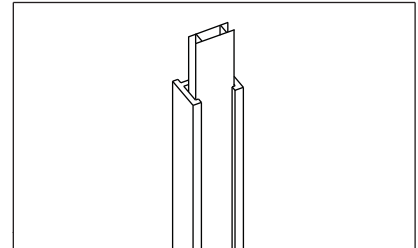

15 WALL RAIL COVERS

Measure the distance between your brackets and cut the covers to match. The covers should be pushed into the rail completely so they are held in position.

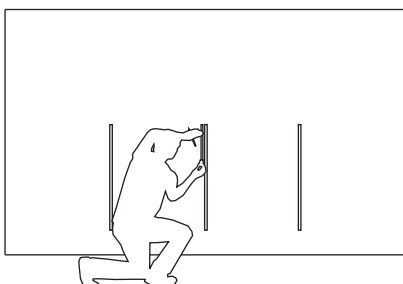

16 FITTING WALL PANELS

If you have wall panels you will need to attach our wall panel fixings to the wall. Use four fixings for each panel and set them out close to the panel corners. Use more or less wall fixings depending on what is required and use the templates provided.

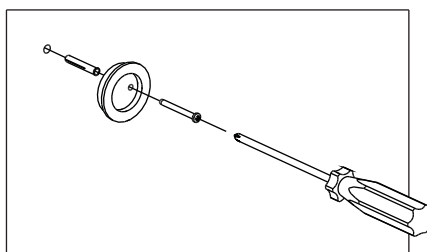

17 WALL PANEL FIXINGS

The panel fixing is screwed onto the wall using the appropriate wall fixings. See page (wall types & fixings page). Position all the fixings so that the hole is positioned at the top which will allow for additional panel movement upwards when rotated.

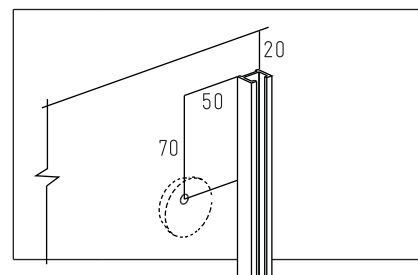

18 MEASURING OUT

Use our templates provided at the back of the installation guide to set out all the locations for the wall panel fixings. Templates are designed for all wall panel widths, but only for 400mm width end panels. Please note the wall panels will sit 20mm above and 20mm below your wall rails.

Follow the final steps below to fit your shelves and connect your lighting. After installation a regular wipe over with a soft cloth to remove any dirt deposits is all that is normally required. Wood shelves or wall panels can be re-oiled or re-waxed after several years to enhance their finish and to improve protection.

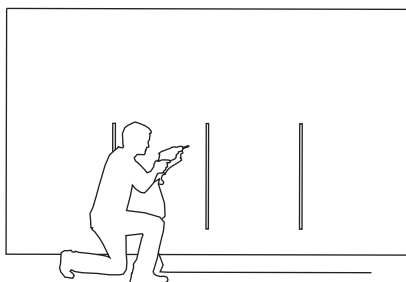

19 CONNECT THE FIXINGS

Drill all the holes required for the wall panel fixings, insert the appropriate wall fixings and tighten the screws to hold the wall panel fixing against the wall. The hole is offset from the centre which allows for the panel adjustment.

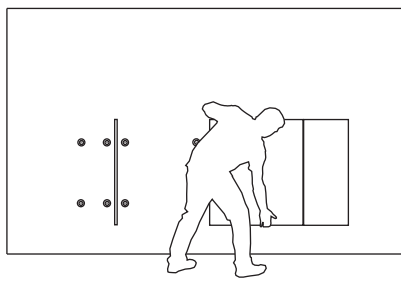

20 ADJUSTABLE PANELS

Lift on the wall panels onto the wall fixings. The panels have a channel at the back that locates onto the wall fixing. The height of the wall panel can be adjusted by twisting the wall panel fixing in either direction. Use the foam packers to stop any movement.

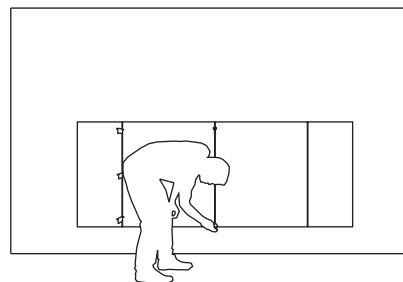

21 SHELF BRACKETS

Slide the shelf brackets into the wall rail either from the top or bottom. The back of the bracket locates into the rail slots. The height of the bracket determines the position and height of the shelves.

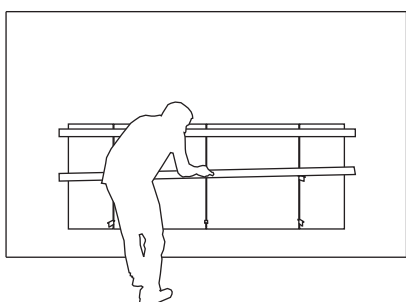

22 FITTING YOUR SHELVES

Ensure the brackets are at the correct heights you would like and lift the shelves onto the brackets. For additional security our VHB dots can be attached to bond the shelf to the bracket, but these are not always essential, just peel off the paper backing.

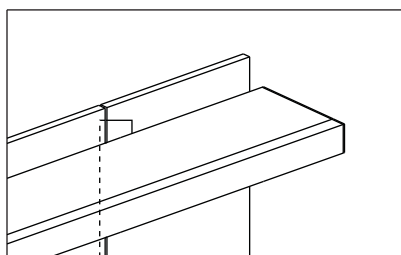

23 SHELVES WITH LIGHTING

Our shelves with undershelf lighting come fitted with the cables taped to the back of the shelf ready to install. Untape the cables. The cable hole should line up with one of the wall rails. Insert the end of the cables into the wall rail and feed them down the length of the rail.

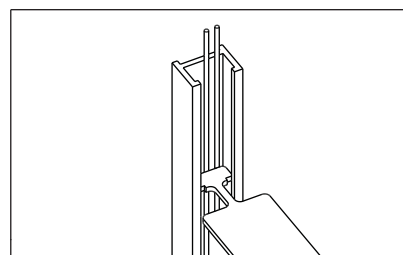

24 LIGHTING CABLES

The led cables fit behind the bracket, so that the shelf heights are still adjustable, use a rail cover supplied to conceal the wires and fixings. Cut the cover to the correct length and push them into the rail. You can add a little diluted washing up liquid to make it easier.

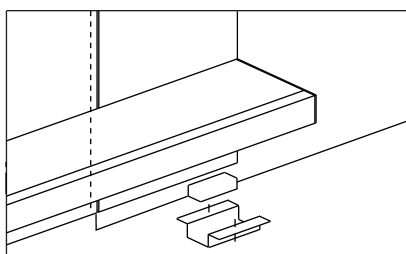

25 CONCEALED CABLING

Ensure the cables run down inside the wall rail, behind any brackets and comes out at the bottom near the floor. Connect the cables to the driver and use a cable tray to position it underneath the lowest shelf, alternatively fix it to the wall or conceal it remotely.

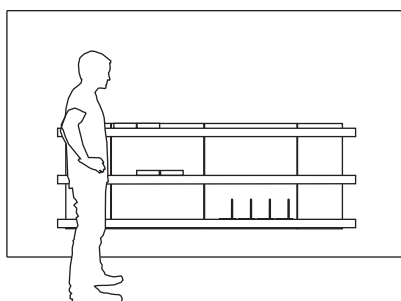

26 FINISHING OFF

You can connect all your cables to the single driver supplied. Plug in the driver to a (UK) mains power socket and turn on the switch to light your shelves. Place your accessories on the shelves and arrange them to finish off.

Follow your quotation drawing and the steps below to fit your cabinets. We would recommend fitting any shelves first and using two people to fit the cabinets. Your cabinets will come assembled; cabinets with fold down doors can be up to 1200mm in length but cabinets with draws can be made in multiples of 600mm or 900mm (1500, 1800, 2400, 2700, 3300mm etc).

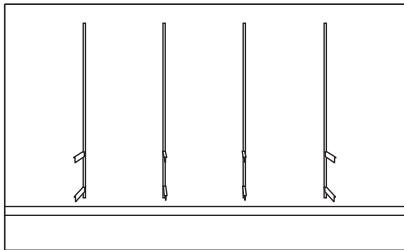

01 TO START

Insert your larger 345 brackets into the wall rails. Ensure they are at the correct heights for the cabinet. For 425 height cabinets you will see 6 slots between the brackets and the 365 height you will see 5 slots.

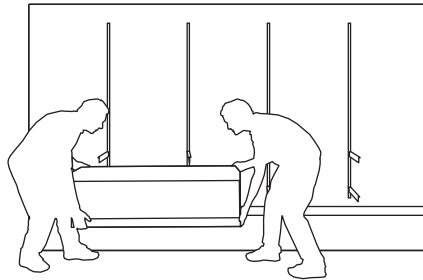

02 LIFT

Face the cabinet in the correct direction, doors facing away from the wall and fixings. Lift the cabinet, one person at each end and raise it up so it is a little higher than the wall brackets.

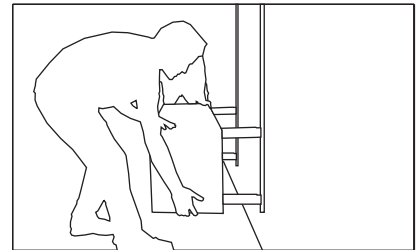

03 POSITION

Guide the cabinet over the brackets until the back of the cabinet is close to the wall and rail. Lower the cabinet on to the brackets, if the brackets are positioned at the correct heights the cabinet will rest on the top and also the bottom brackets. (mind the clips 07)

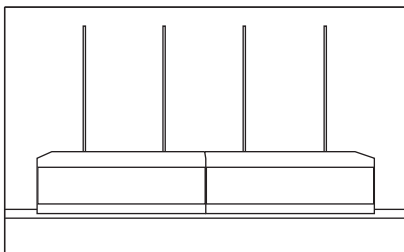

04 MORE THAN ONE

If you are fitting more than one cabinet, repeat the previous steps. Until all of your cabinets are positioned on their brackets. Lift the cabinets again, but only slightly, if you need to adjust their position horizontally, check their position with a tape measure.

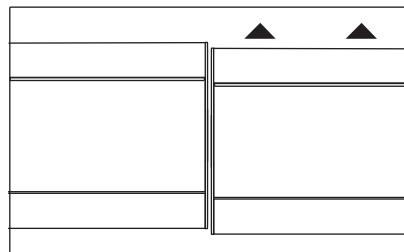

05 LEVEL

Check the heights of your cabinets, if any of the cabinets are at slightly different heights, we have supplied different sized packers to help level them.

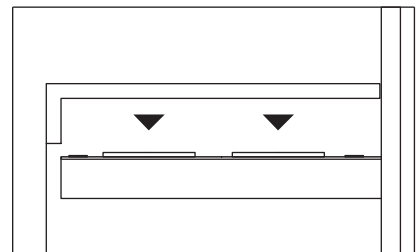

06 ADJUSTING HEIGHT

To adjust the height Insert the correct sized packers between the brackets and cabinet to raise it up. The packers have different thicknesses so combinations can be used together to achieve the correct height.

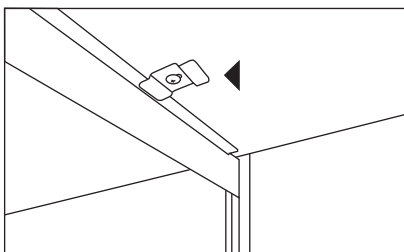

07 SECURING YOUR CABINET

Fix them in position by twisting the clips located inside & under the cabinet top. Rotate the clip so that it partially holds a 345 bracket, repeat this with all your clips. The clips can be repositioned if required, the self drilling screw can be used to drill a new hole in a different location. Loosen the screw if the clips are too tight and retighten on the bracket.

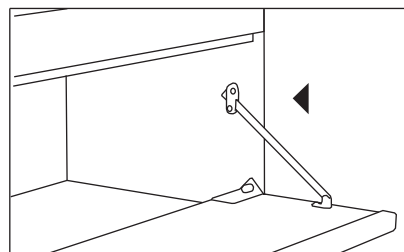

08 FOLD DOWN DOORS

The flap stays can be adjusted on both sides to control the movement of the door. Use an allen key (M4 bolt) to tighten the screws to have a slower motion or loosen them to speed it up. Test the motion by slowly tightening or loosening the screws, don't loosen the screws too much as this will disconnect the stay from the cabinet side.

Please contact us below at our studio and workshop. Speak to one of our planners for our free planning service.

ON&ON creative systems Ltd.
Unit 6 Executive Park,
Hatfield Road, St Albans,
Hertfordshire, AL1 4TA

T- +44 (0)1727 834 043
E- Studio@madebyonandon.com
W- www.madebyonandon.com

We are open:

Monday 9.30am – 5.00pm

Tuesday 9.30am – 5.00pm

Wednesday 9.30am – 5.00pm

Thursday 9.30am – 5.00pm

Friday 9.30am – 3.30pm

and closed on UK public holidays.