

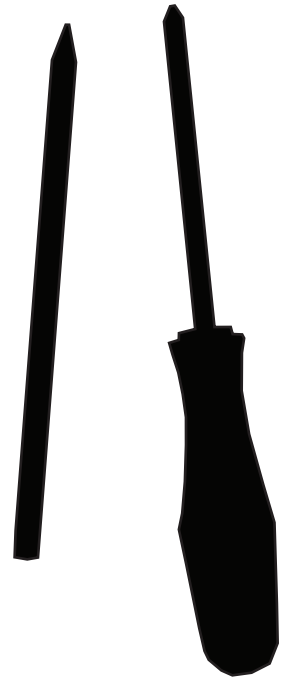

We have made the shelving system as simple as possible to install and any competent builder or handyman should be able to fit the system. Please follow the guide accurately as it's important to install the system correctly and the quality of the installation can effect its performance. The size of load it can carry will also depend on the strength of the wall (eg brick or plasterboard) and the fixing method to carry its load (wall plugs or cavity wall fixings).

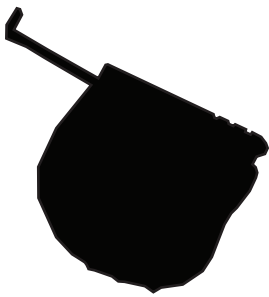

NB* PIPES AND ELECTRICS

Before drilling any holes in your walls always check for any services behind (pipes & cables). Detectors are available from most DIY stores and once installed never sit or stand on your shelving system.

WORKING AT HEIGHT

Ensure you follow suitable health & safety guidelines when working at height. Our systems are usually fitted below 2.4metres in height and only a small height increase may be required. We recommend using a suitable, stable and level 'work platform' to install from and not a ladder when drilling holes.

LONG SHELVES

We would recommend using 2 people to fit our shelving system if any of the shelves are over 3 metres in length. Our deepest shelves (345) can also weigh up to 24kgs (5m length).

The diagram below shows all the parts to the standard system and how they go together. The wall rails screw directly into the wall, all the other parts are connected to them creating a very strong wall shelving system. Your system may not have all these parts but the principles will be the same.

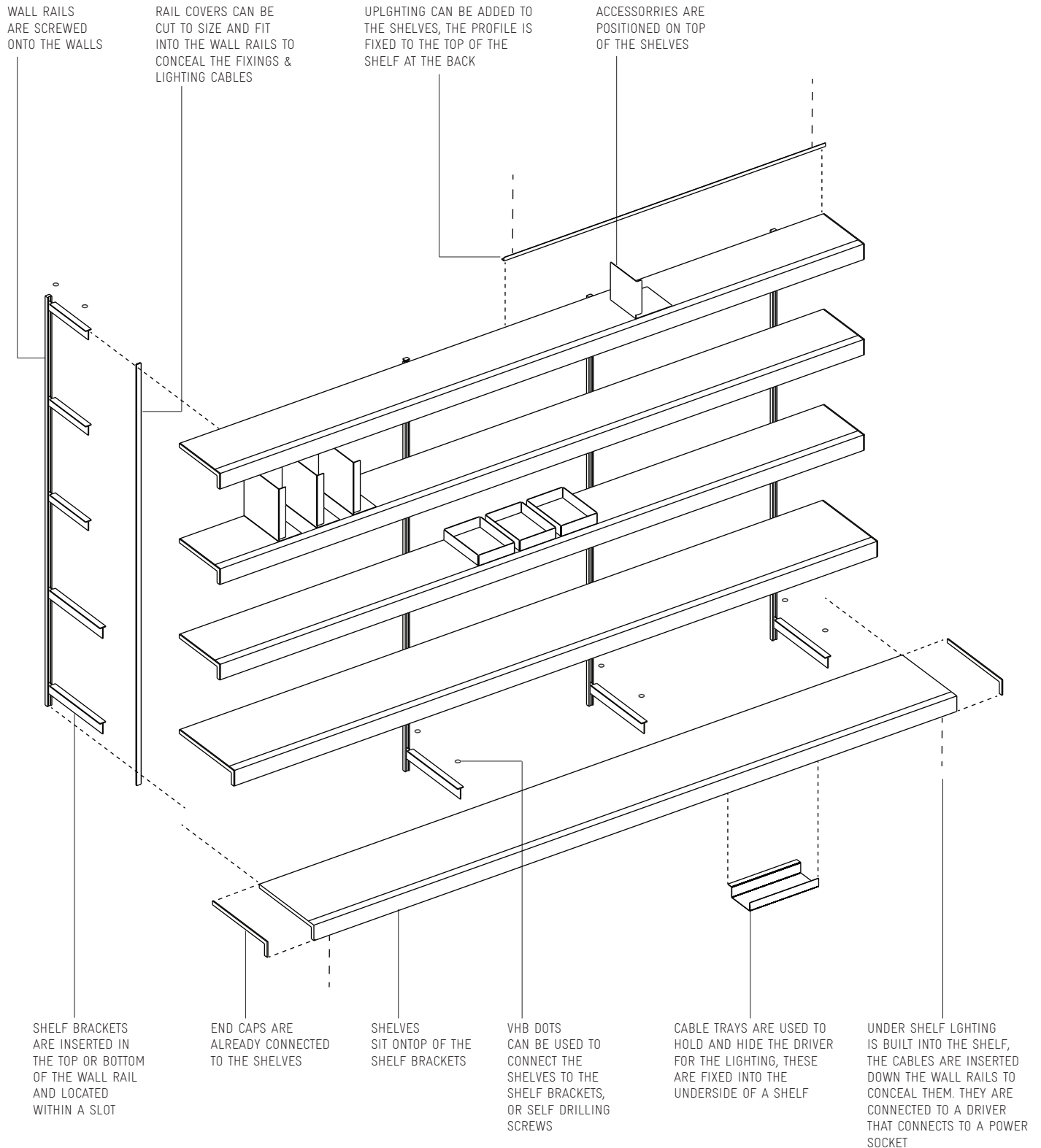

The diagram below shows additional parts to the shelving system and how they go together. These parts can be designed into your system at the beginning or added to at a later stage. If you want to move your system in the future and if required we can also resize your shelves and rails to suite a new configuration.

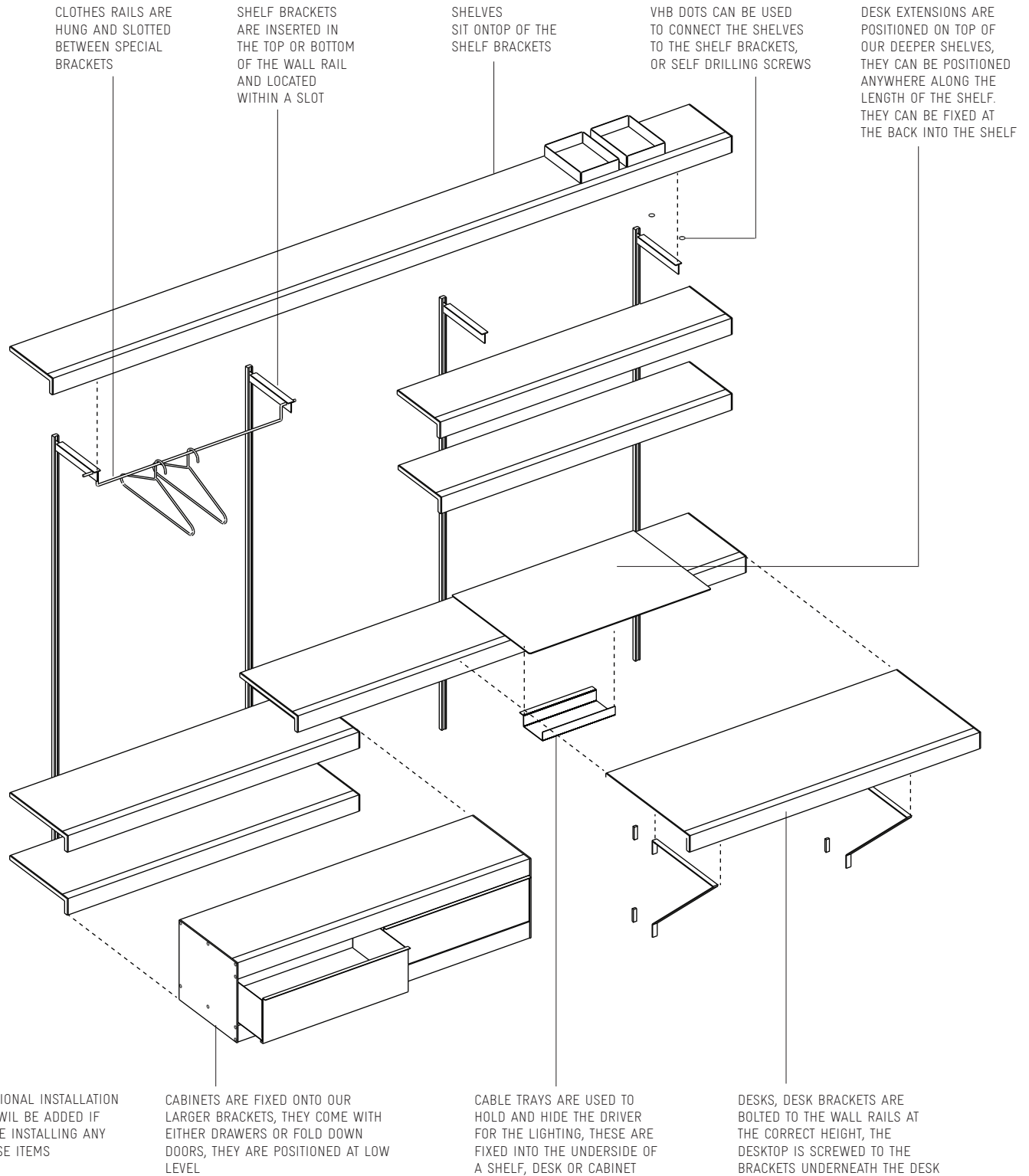

It is important to know what type of wall you are fixing the shelving system to. Below we have listed the most common types of wall and our fixing method. We supply fixings that work on both solid or cavity walls. The same fixing can be used for Dot and Dab walls see page 5.

NB* When you are drilling holes in the wall ensure you wear safety glasses or similar to protect your eyes

NB* Follow TIP2, Drill a test hole to make sure the fixing works

TIP1 Drill a test hole (50mm) below your first fixing hole, here you can test that the fixing works correctly before drilling all your holes. The top hole is the most important must be fixed securely.

TIP2 If you make a mistake drilling holes or have crumbling brick walls you can enlarge the hole and refill the hole using epoxy putty which can be re-drilled when hard.

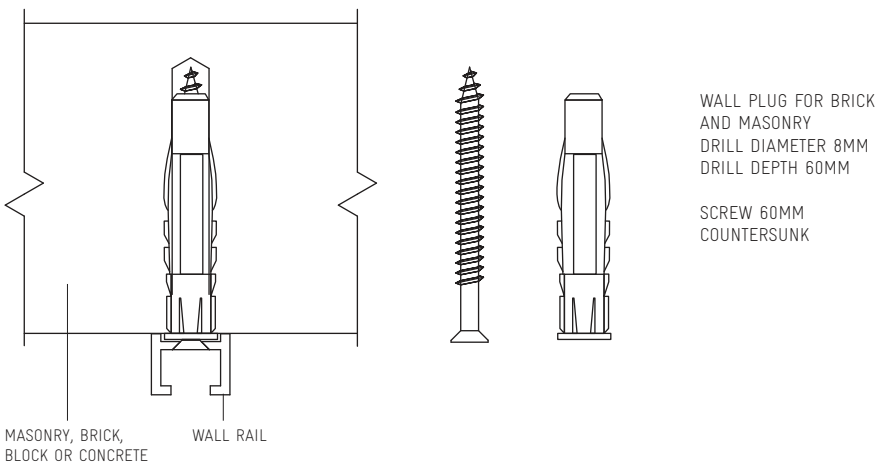

SOLID WALLS (BRICK)

Use the hammer setting on the drill. Drill the hole (60mm deep) with a masonry drill bit and then clean the hole. Insert the plug and tap until flush with the hole. Tighten the screw using the correct screwdriver. We would always recommend tightening the last part by hand to ensure it's fixed correctly. You should be able to keep tightening the screw by hand until it stops rotating. If the screw ever spins you may have damaged the plug or drilled the hole to wide.

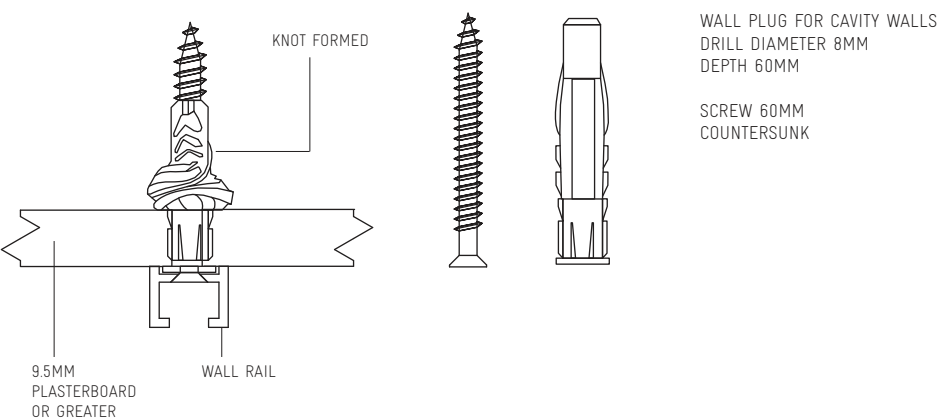

CAVITY WALLS (PLASTERBOARD)

Use this universal wall plug for any cavity wall or plasterboard wall that has a thickness of 9.5mm or more. Fitted correctly these are exceptionally strong, they require the longer screws supplied (60mm). When tightened the screw pulls the plug back to form a knot behind the plasterboard.

Drill a 8mm diameter hole through the plasterboard, insert the wall plug and, tap it with a hammer until the collar is flush with the plasterboard. Use a powered screwdriver to tighten the screw partially fitting the rail against the plasterboard. Do not over-tighten (as it could cause the plug to fail). It is best to do the final tightening by hand. You should be able to tighten it until it goes solid with no movement from the screw. If the screw ever spins after fully tightening remove the wall plug with pliers from the wall and insert another.

Dot and dab walls comprise a solid wall with plasterboard stuck onto it using "dabs" of adhesive. This creates a small void (usually around 10-20mm) in the wall which is faced with plasterboard.

Below we have shown how to fit our shelving systems to a Dot and Dab plasterboard wall. If there are any problems alternatively much longer fixings can be used to fix back into the solid wall behind.

NB* When you are drilling holes in the wall ensure you wear safety glasses or similar to protect your eyes

DOT AND DAB WALLS

Use the hammer setting on the drill. Drill the hole (60mm deep) with a masonry drill bit. The drill bit will pass through the plasterboard layer, continue pushing the drill past the small cavity to touch the solid wall behind. Drill the out the solid wall to your 60mm depth.

Clean the hole. Insert the wall plug and tap until flush with plasterboard. Tighten the screw using the correct screwdriver. We recommend tightening the last part by hand. It is important to tighten to make sure the back of the plug is pulled back and a knot is still formed in the small cavity. You should be able to keep tightening until it stops rotating.

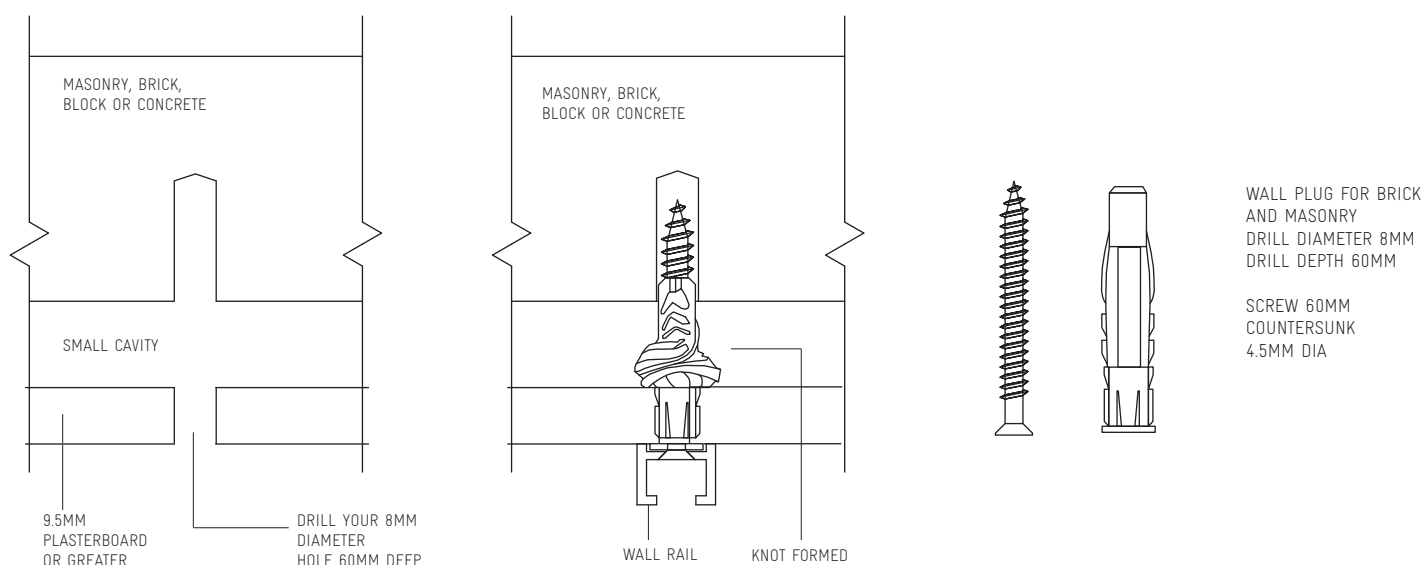

The system can take very heavy loads, but it does depend on the quality of the installation, quality of wall and fixing method. We recommend that all the fixing points on the wall rails are used (every 15cm) and that the appropriate fixing is used for your wall type, please see our wall types & Installation Guide.

NB* You must not sit or stand on any part of the shelving system.

1. OUR RECOMMENDED HEIGHT BETWEEN SHELVES IS OVER 33.5CM (335MM). ALTERNATIVELY THEY CAN BE POSITIONED AT ANY DISTANCE APART IN 5CM (50MM) INCREMENTS.

2. THE WALL RAIL CENTRES CAN VARY BUT STANDARD DISTANCES ARE 65 OR 80CM APART, AND THE SHELVES ARE CENTRED HORIZONTALLY ACROSS THEM.

3. WE WOULD NOT RECOMMEND SPANNING A DISTANCE GREATER THAN 120CM (1200MM) BETWEEN THE WALL RAILS. ENSURE THE RAILS ARE SET OUT CORRECTLY SO THAT BOTH REMAINING ENDS OF THE SHELVES ARE EQUAL IN LENGTH AND OVER 10CM (100MM). THIS ENSURES STABILITY AND HELPS TO CREATE AN EQUAL LOAD.

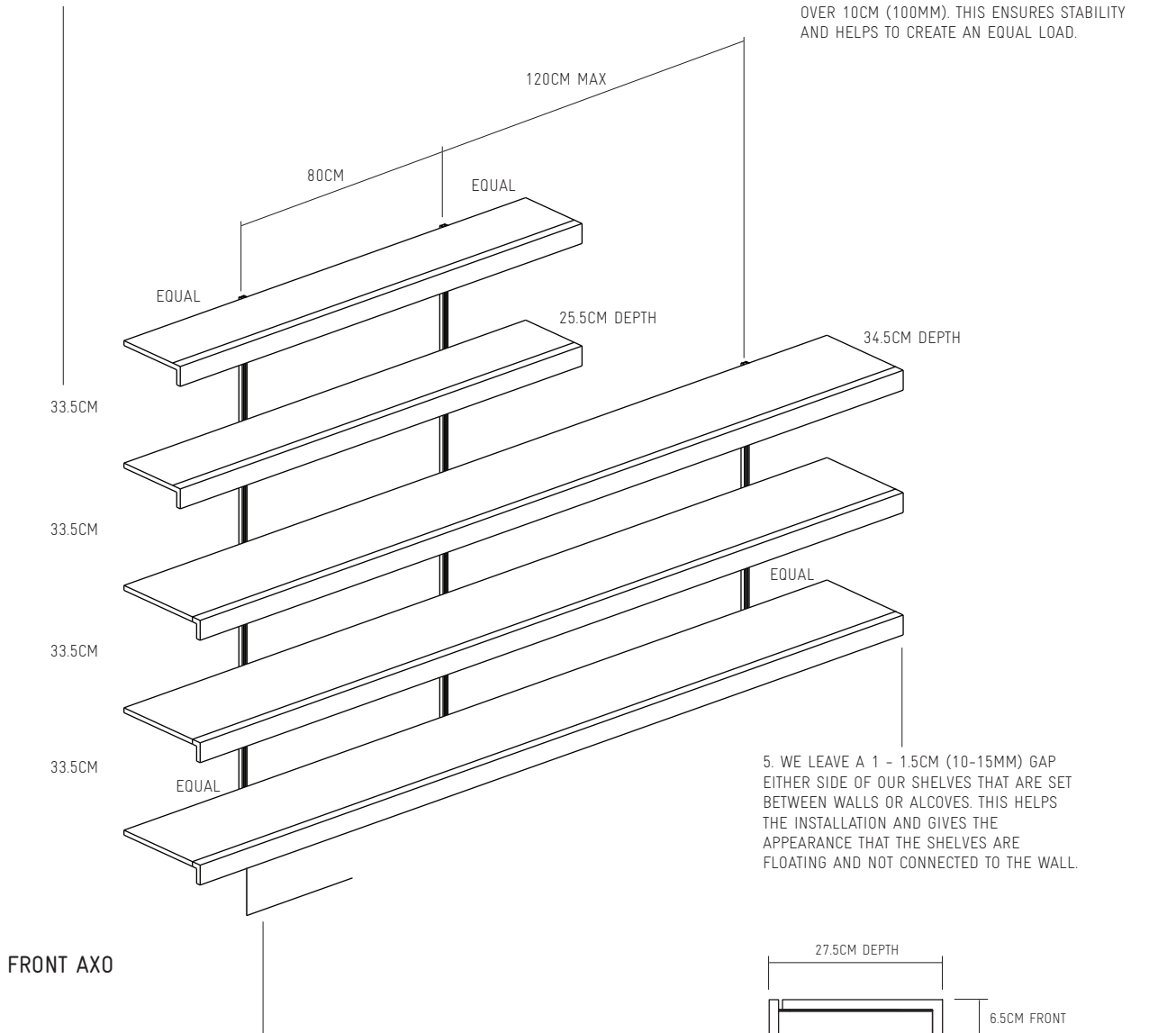

FRONT AXO

4. OUR LIGHTING SHELF USES LOW ENERGY LED STRIPS. THE LED CABLES ARE CONCEALED WITHIN THE SHELF AND RUN DOWN THE INSIDE OF A WALL RAIL. THE DRIVER THAT POWERS THE STRIPS CAN BE LOCATED ON THE UNDERSIDE OF THE BOTTOM SHELF, CABINET OR DESK, BUT THE DRIVER DOES NEED TO BE CONNECTED TO A STANDARD POWER SOCKET (UK UNLESS REQUESTED). SEE OUR LIGHTING PAGE FOR MORE DETAIL.

6. DON'T POSITION A BRACKET AT THE VERY BOTTOM OF THE WALL RAIL. LEAVE 5CM/50MM

5. WE LEAVE A 1 - 1.5CM (10-15MM) GAP EITHER SIDE OF OUR SHELVES THAT ARE SET BETWEEN WALLS OR ALCOVES. THIS HELPS THE INSTALLATION AND GIVES THE APPEARANCE THAT THE SHELVES ARE FLOATING AND NOT CONNECTED TO THE WALL.

SIDE VIEW

7. SHELF DEPTH, ADD AN ADDITIONAL 2CM FOR THE WALL FIXINGS, THE TOTAL SHELF DEPTHS ARE 27.5CM AND 36.5CM FROM THE WALL TO FRONT FACE OF THE SHELVES.

Follow the steps below to fit your shelves and connect your lighting. There are individual pages to follow for cabinets, desks, desk extensions and an additional lighting sheet. We will provide you with the correct setting out drawings and fixings for your walls, but if you do not want to install the system yourself, any competent builder or handyman will be able to fit the system for you.

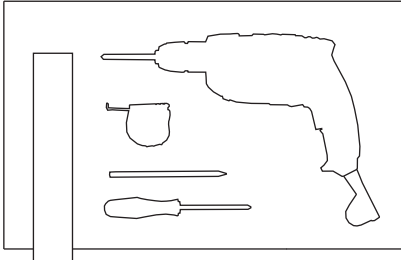

01 TOOLS FOR THE JOB

Tools for the job:
Tape measure, pencil, spirit level (80-100cm), 8mm drill bit (general purpose or masonry), drill with hammer setting (power), driver (power), screwdriver, detector (cables & pipes).

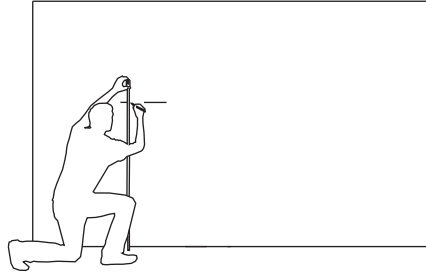

02 MARK OUT THE SYSTEM HEIGHT

Use our quotation as a template to set out your system. Use a tape measure to mark out the height of the top of the first wall rail. Position the wall rail & mark the top hole position, mark the hole centre. The wall rail top hole is labeled on the wall rail.

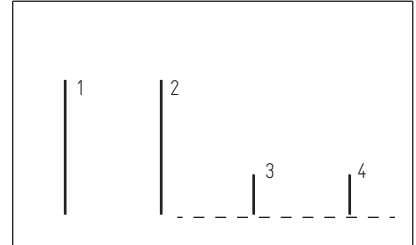

03 DIFFERENT RAIL HEIGHTS

If your system includes wall rails of different heights you'll need to fix the longer wall rails in position first. Then set out the smaller rail positions from the bottom using a spirit level as the fixing holes may not line up.

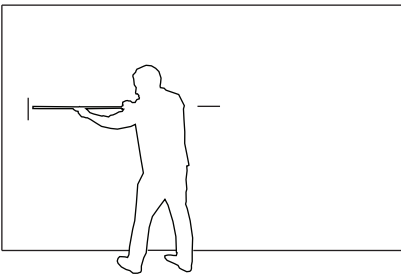

04 POSITIONING THE FIRST RAIL

Now you have the correct height the aim is to mark out all the top hole rail positions. Use a tape measure to set out the first wall rail, measure the correct distance away from a side wall or similar. Mark the centre of the top rail hole, so it's in the correct horizontal location.

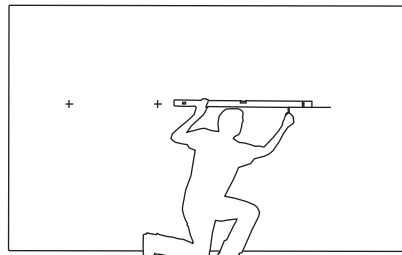

05 THE OTHER RAILS

Use a measure to mark out the position of the other wall rail top holes from your first hole location. Rails are usually set out every 800mm but check your setting out drawing. Next work along with a spirit level to mark/level all the hole heights.

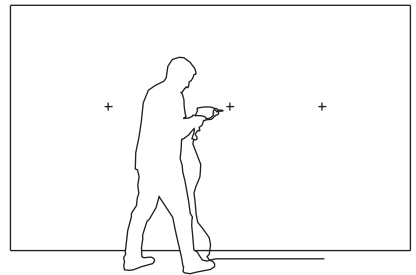

06 FIXING A WALL RAIL

Drill the top hole for the first rail (after your test hole). Use the appropriate drill bit/ wall fixing and insert the wall plug. The top holes are the most important to get right and accurate. Follow all our fixing tips on page 4.

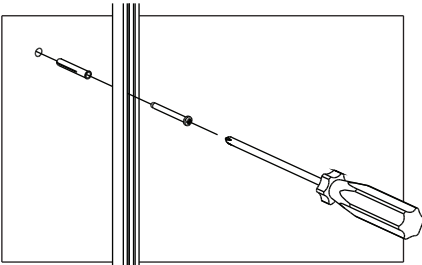

07 WALL RAIL

Screw in the wall fixing and rail against the wall, check that your top hole fixing works and is sound. If correct loosen your fixing slightly and the wall rail will now hang in place.

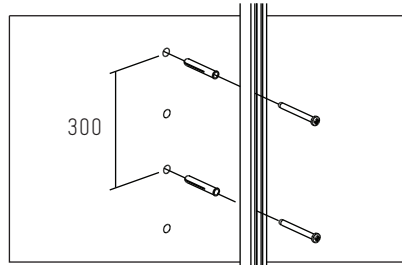

08 WALL FIXINGS QUANTITY

Your wall rails have fixing points every 15cm/150mm but if you are fixing your system to solid walls (brick/concrete block etc) you may be able to use only every other point 30cm/300mm, but this does depend on the quality of the wall or loading required.

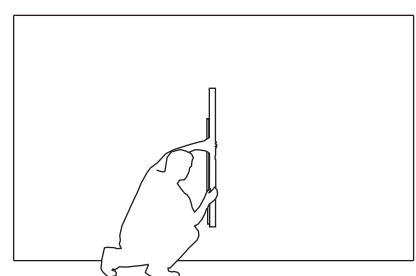

09 ALL VERTICAL HOLES

Ensure the wall rail is hanging vertically using a spirit level. Use the rail holes to mark out the centres of the remaining holes. Re-check your hole locations as it's important they are accurate and that you position the mark in the centre of the holes.

Continue following the next steps below to fit your shelves, rail covers. If there are any problems during the installation we are always happy to help, you can contact us on +44 (0)1727 834034 or email us at studio@madebyonandon.com.

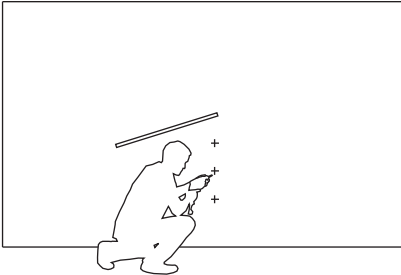

10 DRILL THE HOLES

Swing the rail to one side, you may be able to tighten your top fixing so that the rail stays in place. Drill all the holes marked out below to the correct depth and clean the holes to remove any loose particles or dirt. Insert your wall plugs or wall cavity fixings.

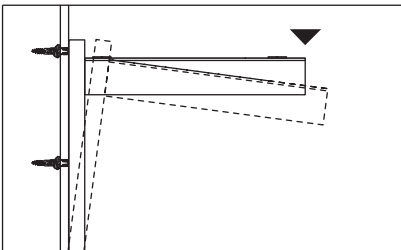

13 TOP FIXING CHECK

*** YOU MUST CHECK YOUR TOP FIXINGS TO ENSURE YOU HAVE FITTED THEM CORRECTLY. PULL DOWN ON A BRACKET WITH ADEQUATE PRESSURE. YOUR RAIL MUST NOT PULL AWAY FROM THE WALL. IF YOUR FIXINGS ARE CORRECT THE WALL RAIL WILL STAY IN CONTACT WITH THE WALL.***

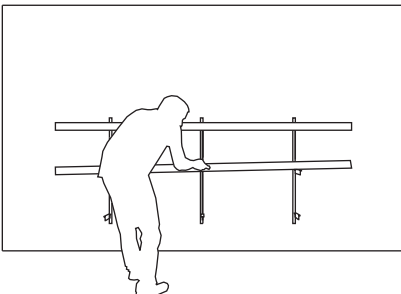

16 FITTING YOUR SHELVES

Ensure the brackets are at the correct heights you would like, they are adjustable by 5cm/50mm up or down, so adjust the heights until you are happy and lift the shelves onto the brackets. If you need to remove a shelf see our removal instructions.

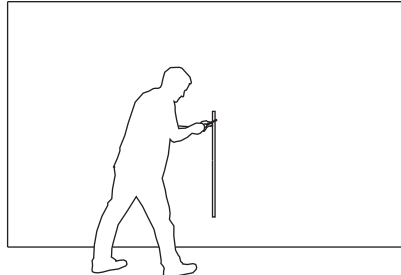

11 CONNECT THE RAIL

Loosen your top hole fixing and swing the rail back into position. Insert the remaining fixings and tighten the screws against the rail. Repeat this for all the other wall rails. The rails should now be firmly connected, check all the screws are tight and fitted correctly.

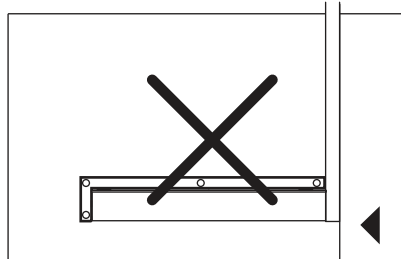

14 NOT AT THE BOTTOM

Do not position your brackets at the very bottom of the wall rails. There should be at least 50mm / 5cm of additional wall rail below the bracket to add to the strength.

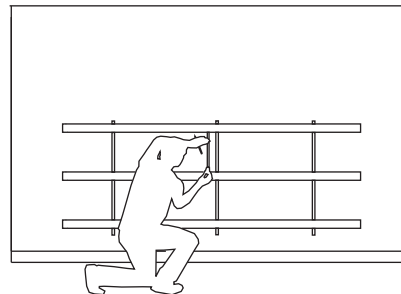

17 WALL RAIL COVERS

These can be fitted to your wall rails to conceal any screw fixings and slots, or if you are fitting shelves with lighting they will conceal any lighting cables.

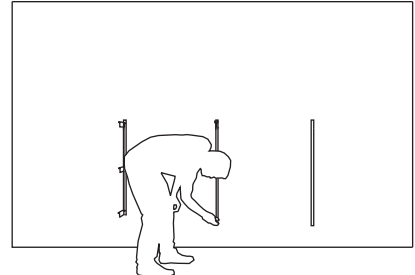

12 SHELF BRACKETS

With all the wall rails fixed in place you can slide the shelf brackets into the wall rail either from the top or bottom. The back of the bracket locates into the rail slots. The height of the bracket determines the position and height of the shelves.

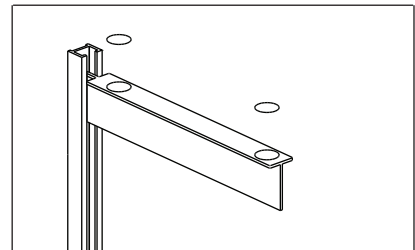

15 FIXING YOUR SHELVES

Use our VHB dots to bond the shelf to the bracket to stop any movement, just peel off the paper backing and lower the shelf down on top. We can supply self drilling screws for a stronger fixing if required.

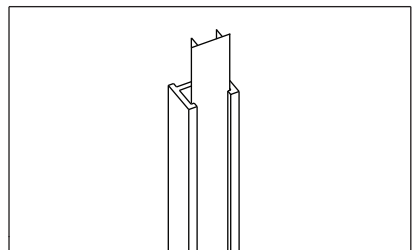

18 WALL RAIL COVERS

Measure the height between your brackets and cut the covers to match. The covers should be pushed into the rail completely. Use diluted washing up liquid and the back of a plastic spoon (or similar) to help to insert the covers, or see our news/blog video.

Follow the final steps below to fit your shelves and connect your lighting. After installation a regular wipe over with a soft cloth to remove any dirt deposits is all that is normally required, but see our care and maintenance page at the back for more detail.

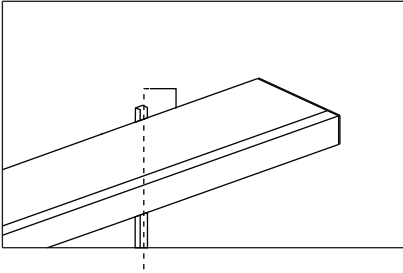

19 SHELVES WITH LIGHTING

Our shelves with undershelf lighting come fitted with the cables taped to the back of the shelf ready to install. Untape the cables. The cable hole should line up with one of the wall rails. Insert the end of the cables into the wall rail, behind the bracket and feed them down the length of the rail. (see our lighting page)

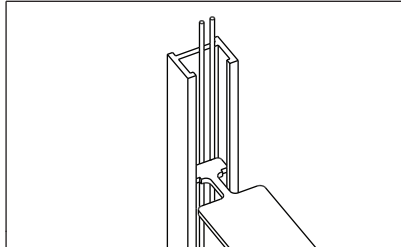

20 LIGHTING CABLES

The led cables fit behind the bracket, so that the shelf heights are still adjustable, use a rail cover supplied to conceal the wires and fixings. Cut the cover to the correct length and push them into the rail. Use the back of a plastic spoon or similar and diluted washing up liquid to help insert it.

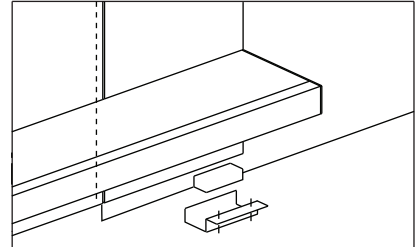

21 CONCEALED CABLING

Ensure the cables run down inside the wall rail, behind any brackets and comes out at the bottom near the floor. Connect the cables to the driver and use a cable tray to position it underneath the lowest shelf, alternatively fix it to the wall or conceal it remotely.

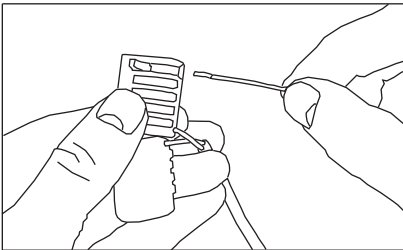

22 CONNECTING THE DRIVER

Connect the lighting leads to the driver using the wago clips. Connect the marked lead to the positive (driver red wire) and negative leads to the negative (driver black wire). Pull back the orange clips until they click upright, insert the lead fully and close the lever to make the connection, repeat with all the leads from the shelves to make the circuits.

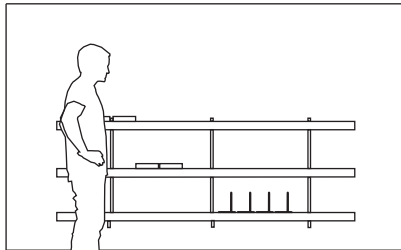

23 FINISHING OFF

After completing the circuit plug in the driver to a (UK) mains power socket and turn on the switch to light your shelves. Make sure any loose cables are tidied up or shortened if required, use the cable ties supplied and position them into the cable tray. Place any of our accessories on the shelves and arrange them to finish off.

Follow your quotation drawing and the steps below to fit your cabinets. We would recommend fitting any shelves first and using two people to fit the cabinets. Your cabinets will come assembled; cabinets with fold down doors can be up to 1600mm in length but cabinets with drawers can be made in multiples of 600mm or 800mm (1600, 1800, 2400 etc).

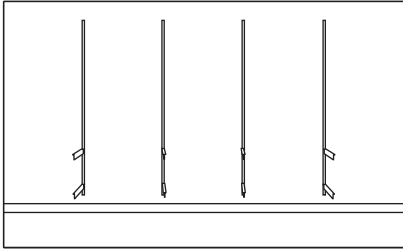

01 TO START

Insert your larger 345 brackets into the wall rails. Ensure they are at the correct heights for the cabinet. For 415 height cabinets you will see 6 slots between the two brackets. Use every rail & all brackets top and bottom.

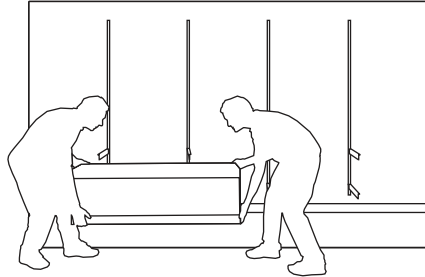

02 LIFT

Face the cabinet in the correct direction, doors facing away from the wall and fixings. Lift the cabinet, one person at each end and raise it up so it is a little higher than the wall brackets.

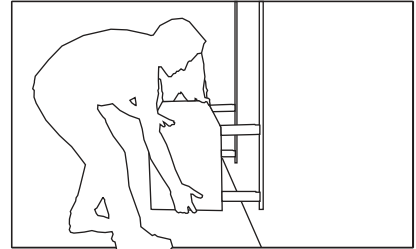

03 POSITION

Guide the cabinet over the brackets until the back of the cabinet is close to the wall and rail. Lower the cabinet on to the brackets, if the brackets are positioned at the correct heights the cabinet will rest on the top and also the bottom brackets. (mind the clips 07)

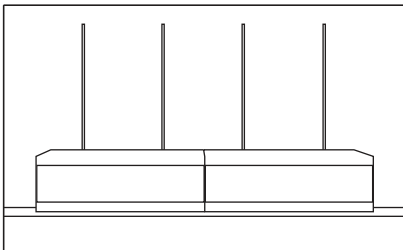

04 MORE THAN ONE

If you are fitting more than one cabinet, repeat the previous steps. Until all of your cabinets are positioned on their brackets. Lift the cabinets again, but only slightly, if you need to adjust their position horizontally, check their position with a tape measure.

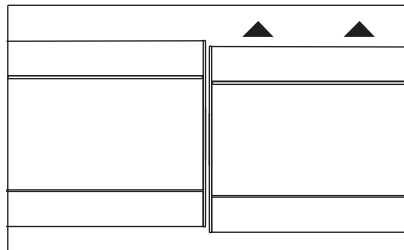

05 LEVEL

Check the heights of your cabinets, if any of the cabinets are at slightly different heights, we have supplied different sized packers to help level them.

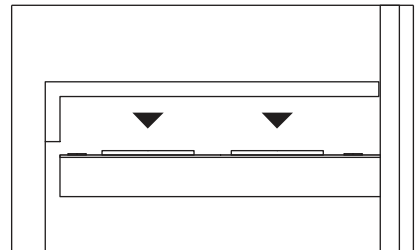

06 ADJUSTING HEIGHT

To adjust the height Insert the correct sized packers between the brackets and cabinet to raise it up. The packers have different thicknesses so combinations can be used together to achieve the correct height.

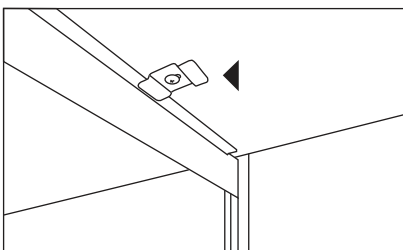

07 SECURING YOUR CABINET

Fix them in position by twisting the clips located inside & under the cabinet top. Rotate the clip so that it partially holds a 345 bracket, repeat this with all your clips. The clips can be repositioned if required, the self drilling screw can be used to drill a new hole in a different location. Use the self drilling screws provided through the bracket holes for additional security.

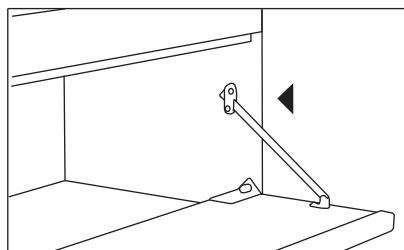

08 FOLD DOWN DOORS

The flap stays can be adjusted on both sides to control the movement of the door. Use an allen key (M4 bolt) to tighten the screws to have a slower motion or loosen them to speed it up. Test the motion by slowly tightening or loosening the screws, don't loosen the screws too much as this will disconnect the stay from the cabinet side.

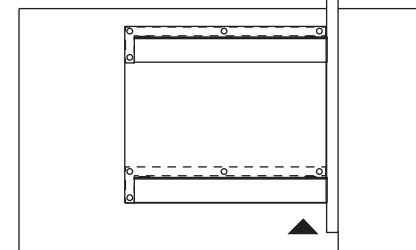

09 *NOTE: FIX YOUR DRAWERS

CABINETS WITH DRAWERS MUST BE LOCKED INTO POSITION WITH THE FIXING CLIPS AND A MINIMUM OF 2 SELF DRILLING SCREWS TO BE USED TO CONNECT CABINETS TO THE BOTTOM WALL BRACKETS. SCREW THROUGH THE BRACKET CLEARANCE HOLE INTO THE UNDERSIDE OF THE BOTTOM OF THE CABINET TO FIX IN POSITION.

Fit your wall rails and shelves first using the primary installation guide and then follow the steps below to fit your desk. We would recommend using two people to fit the desk if it is over 2m in length. Cable trays can be purchased and fitted to the underside of the desk to help cable management or to hold your driver for any shelves above the desk with lighting.

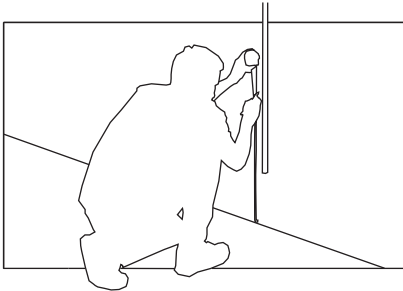

01 TO START

Start by marking out the top height of your desk bracket, this is typically 700mm from the floor (720mm desk height). Use a tape measure and pencil to mark the rail front, this will be the top of the desk bracket but check your quotation drawing for a different height.

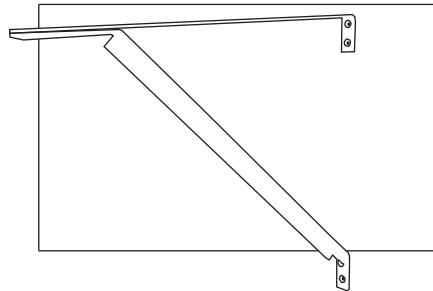

02 DESK BRACKET

Depending on the length of your desk you may have more than two desk brackets, fit one at a time. For every desk bracket there are 2 x silver aluminum fixing blocks that are used to clamp the bracket to the wall rail.

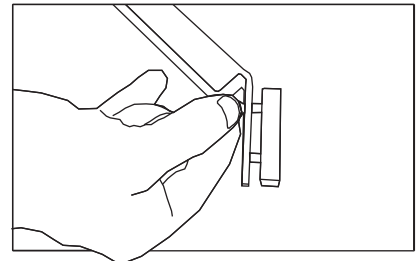

03 ATTACHING THE BRACKET

Partially connect the first fixing block to the bottom of the bracket with 2 x bolts provided. Don't tighten this, keep it very loose.

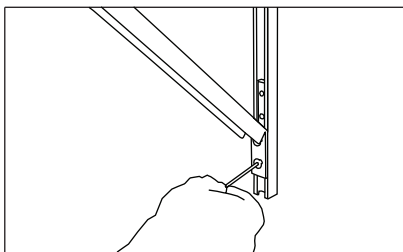

04 FIX THE BRACKET BOTTOM

Slide the second fixing block into the bottom of the wall rail, hold this in place. Next slide the first fixing block partially connected to the bracket into the wall rail, push the whole bracket up so that the top is close to the 700mm mark and slightly tighten the screws.

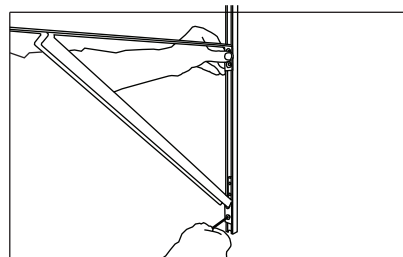

05 FIX THE BRACKET TOP

Partially connect the top fixing block (already inserted into the rail) using the 2 x bolts. Next position the top of the bracket in line with your 700mm mark, you may have to loosen the bolts to move the bracket. Then tighten the top fixing block bolts to clamp it in place.

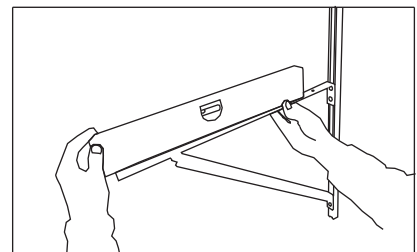

06 LEVEL

Position a spirit level as shown on top of the bracket. Slide the bottom fixing block up or down (bolts are loose) to change the level of the bracket. When the bracket is either level or slightly raised up tighten and clamp the bottom fixing block in place.

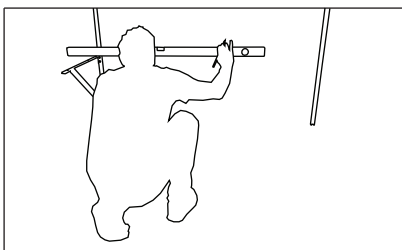

07 FIX ALL THE DESK BRACKETS

Use the top of the first bracket and a spirit level to mark the heights across on to your other wall rails. Repeat the last steps to fix all the brackets in place. Once complete check that all your bolts are tightened and the fixing blocks fully clamped.

THE BOLTS MUST BE TIGHTENED HARD

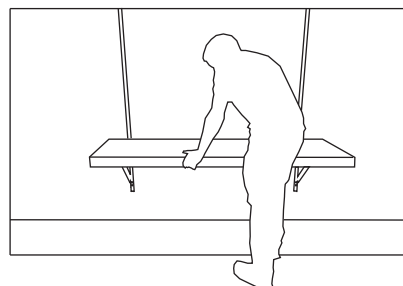

08 POSITION THE DESK TOP

Place your desk top in position and on top of your desk brackets. Following your quotation drawing to make sure it is correctly positioned.

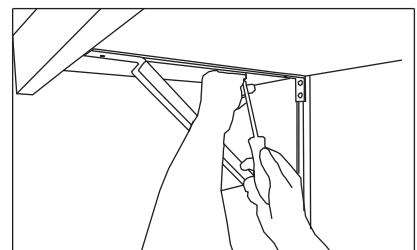

09 FIX THE TOP

Use the wood screws provided to fix the desk top to the brackets. ***YOU MUST USE AT LEAST 2 SCREWS PER BRACKET TO HELP STRENGTHEN AND STABILISE THE DESK***

Complete the installation by fixing all the brackets to the desk.

All our systems with lighting use led strips built into the shelves and these are connected to a driver that is then plugged into a mains socket or similar. The system should be designed so that the driver and wiring is located close to the mains socket.

CAUTION: Low voltage electronics are generally considered safe and pose relatively low shock hazard. However, we strongly recommend that you turn off the power to, or unplug, the power supply prior to adjusting or fitting any LED strips or accessories.

NOTE:

- Our standard drivers are not dimmable
- Colour temperature 3000k
- Standard lighting strip is 9.6W per metre
- Retail lighting strip is 14.4W per metre

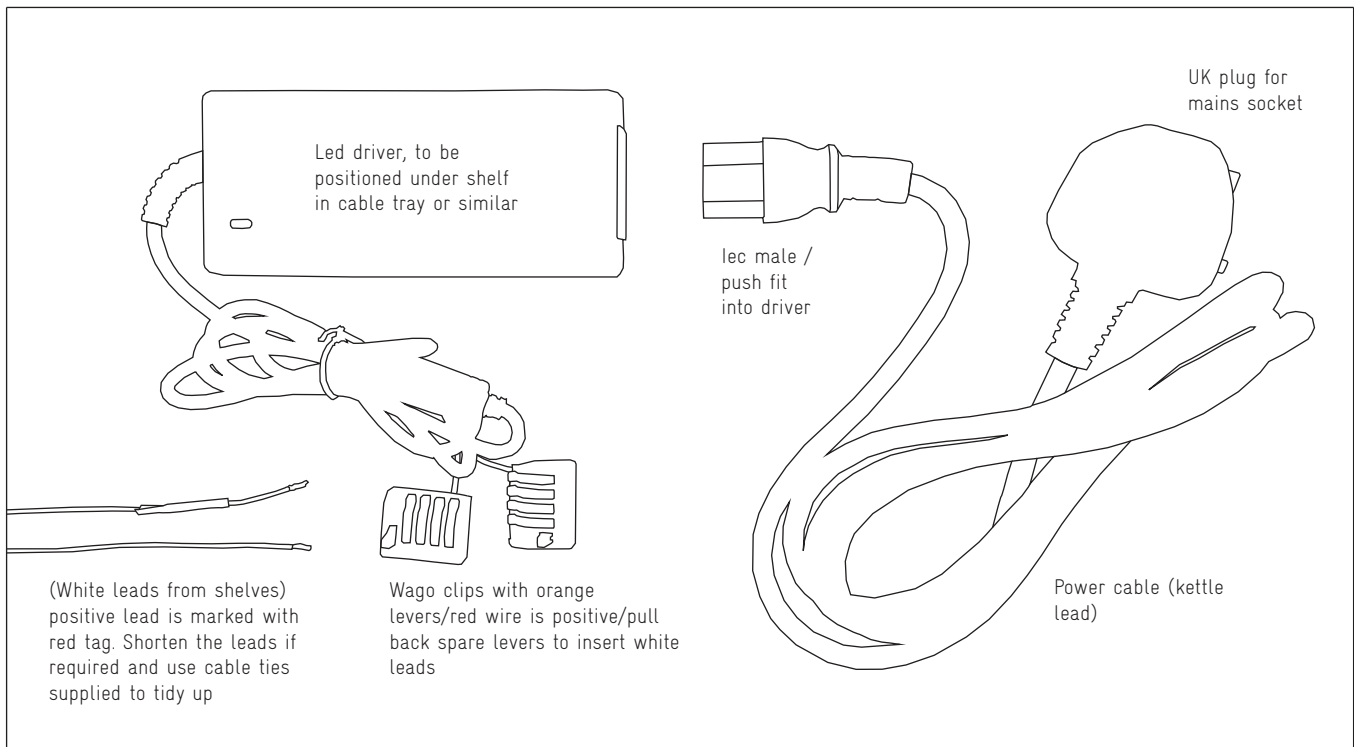

01 TRAY POSITION

The cable tray can be fixed out of site underneath a shelf, choose a position close to the wall rail where the white leads are located and close to your wall socket.

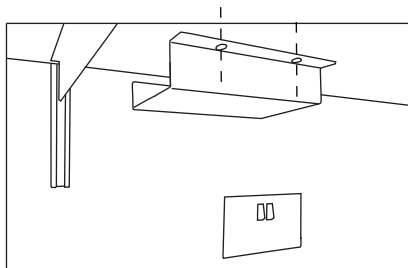

03 WIRING

Connect the power cable IEC end to the driver and position the driver into the cable tray. Then if necessary resize the white leads from the shelves or use the cable ties supplied to coil up any excess.

02 FIT THE TRAY

The tray is fixed in place using two self drilling screws, this can be done when the shelf is in place, if you are not confident mark where you would like the tray and take the shelf off. Place the shelf upside down (cover the surface first) and then use the self drilling screws to screw the tray in place.

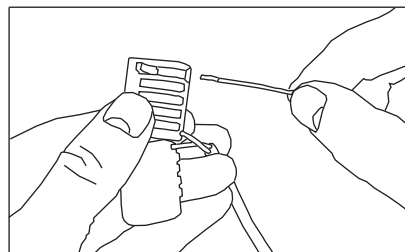

04 MAKE A CIRCUIT

Connect the white leads to the driver using the wago clips, connect the positive (red wire) to the positive (red wire) and negative (black wire) to negative (black wire). Pull back the orange clips until they click upright, insert the lead fully and close the lever to make the connection, repeat with all the leads from the shelves to make the circuits.

02 FIT THE TRAY (CONT...)

Use a power driver, apply some pressure on the screw as it's rotating and it will cut into the aluminium and make its own hole, you can use the tray first to mark the hole positions. The screws are not long enough to go through to the visible side of the shelf.

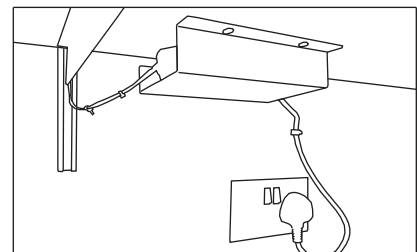

05 FINISH OFF

Cables on either side of the driver can be tidied up with the cable ties supplied and positioned within the cable tray. Use the cable clips (with nail) on the wall to secure the power cable. Insert your UK plug into the mains wall socket and use the wall socket switch to turn your shelf lighting on and off.

If you need to remove a shelf or reposition one you will need to read the instructions below:

1. First check to see if any of the shelves have been secured in place using self drilling screws, these could be connected through several shelf brackets per shelf.
 2. If no screws are located the shelves are just connected using our VHB adhesive pads between the bracket and underside of a shelf. If screws are located remove them before following the next steps to release a shelf from the bracket.
 3. Hold the front of the shelf with one hand (if shelves are very long (over 2.4m use 2 x people to help)
 4. Use your other hand to pull up the back of the shelf, keeping the shelf front in the same position.
 5. You may need to pull up sharply at the back for the shelf to come away from the adhesive dots.
 6. The dots should be OK to be reused when the shelf is positioned back on top of the shelf brackets. If not use self drilling screws or contact us for more VHB dots.
-

CARE & MAINTENANCE NOTES

Our shelving system is easy to look after.

- To clean your shelving, desks and cabinets use a clean damp cloth (non abrasive) to wipe the painted (powder coated finish) surfaces (or laminated desk top or solid wood front)
- You can use a little bit of soap and water, but for a deeper clean use something with a small amount of vinegar. You can either make up your own (diluted white vinegar and water 1/2 ratio)
- Alternatively use a window cleaner that degreases and is streak free. You can spray this directly onto the powder coated surfaces and wipe clean with a dry non abrasive cloth.
- For our shelves with solid wood fronts use a clean damp cloth (not wet) and wipe the wood in the direction of the grain with a warm solution of mild washing-up liquid, don't apply the diluted washing-up liquid direct to the wood front but just dampen the cloth.
- The wood fronts are solid wood so if in years to come they have picked up too much dirt they can be lightly sanded to renew their finish.
- Walnut shelves occasionally have tung oil a natural tree oil applied to bring out the grain and colour, this can be reapplied if needed. If any of your wood surfaces become wet just wipe them down with a dry cloth to remove any excess liquid.
- After adding larger items or weight to your system, or from time to time check your wall rails are still connected securely to your walls. Check the top of the wall rail to ensure the wall fixings are not failing, the back of the rails should be flat against the wall with no visible movement.
- Never sit or stand on a fitted systems and don't over load the system each shelf bracket is design to take 20kgs but please also follow the setting out principles in the installation guide.
- Standard finishes are powdercoated for all aluminium parts (white satin Ral 9010 or black matt 9005)